

AGL Reference Hardware Specification Document

2019/4/25 Ver 0.2.1

DRAFT

Change History

Version	Date	
0.1.0	2017/10/18	The first edition
0.2.0	2019/4/19	Revised for Step2
0.2.1	2019/4/25	Add section of "5.1. AGL Latest Stable Release Support"

DRAFT

Index

1.	AGL Reference Hardware overview	5
1.1.	Goals of AGL Reference Hardware	5
1.2.	Glossary of Terms	6
2.	System Architecture	7
2.1.	Overview	7
2.2.	Use Case.....	8
2.3.	Major policy	9
2.4.	Major feature.....	10
2.4.1.	Selectable and Interchangeable architecture	10
2.4.2.	Open Interface.....	10
2.4.3.	Vehicle mountable structure	11
2.5.	Optional Feature.....	12
2.5.1.	Selector.....	12
2.5.1.1.	AV control device.....	12
2.5.1.2.	Location of peripheral devices	14
3.	AGL Reference Hardware requirements	15
3.1.	Selectable and Interchangeable Architecture	15
3.2.	Open Interface.....	17
3.3.	Vehicle mountable structure	20
3.4.	Hardware specification.....	21
4.	Peripheral devices and functional requirements	23
4.1.	Video / Audio input peripherals	23
4.1.1.	Camera.....	23
4.1.2.	Optical drive.....	23
4.1.3.	Tuner.....	24
4.1.4.	Microphone	24
4.2.	Video / Audio output peripherals.....	24
4.2.1.	Display	24
4.2.2.	RSE	25
4.2.3.	Cluster / HUD.....	25
4.2.4.	AMP / Speaker	26
4.3.	Data communication peripherals	26
4.3.1.	Vehicle External Network devices	26
4.3.1.1.	DCM / TCU	26

4.3.1.2.	Wi-Fi / Bluetooth®	27
4.3.1.3.	USB.....	27
4.3.1.4.	ETC / DSRC	27
4.3.1.5.	NFC.....	27
4.3.2.	Vehicle Internal Network devices.....	27
4.3.2.1.	Vehicle Network	28
4.3.2.2.	IVI Network.....	28
4.3.2.3.	Vehicle signal	28
4.4.	Other peripherals	28
4.4.1.	Human Input devices	28
4.4.2.	Navigation sensor	29
4.4.3.	USB / SD (Media Storage).....	29
5.	AGL software requirements	30
5.1.	AGL Latest Stable Release Support.....	30
5.2.	Selectable and Interchangeable architecture Support	30
5.3.	Selector Support	30
5.4.	Vehicle Data Abstraction	30
5.5.	Cluster / HUD Support	31
6.	Notices.....	32

DRAFT

1. AGL Reference Hardware overview

1.1. Goals of AGL Reference Hardware

This document defines the specification of the Automotive Grade Linux (AGL) Reference Hardware.

The goals of the AGL Reference Hardware are :

- Defining the scope of peripherals which should be supported by AGL.
- Building Reference Hardware, System Architecture to deal with various requirements from OEMs.
- Reducing the gap of AGL community hardware and product hardware.

DRAFT

1.2. Glossary of Terms

Table 1 Glossary of Terms

Term	Definition
Must	It indicates requirement levels. It means that the definition is an absolute requirement of the specification
Should	It indicates requirement levels. It means that there may be valid reasons in particular circumstances to ignore a particular item, but the full implications must be understood and carefully weighed before choosing a different course.
Optional	It indicates requirement levels. It means that an item is truly optional.
AGL	Automotive Grade Linux
BD	Blu-ray Disc
DCM	Data Communication Module
HAL	Hardware Abstraction Layer
HMI	Human Machine Interface
HU	Head Unit
HUD	Head-Up Display
IVI	In-Vehicle Infotainment
NFC	Near Field Communication
RSE	Rear Seat Entertainment
SoC	System on a Chip
TCU	Telematics Communication Unit

2. System Architecture

2.1. Overview

There are multiple OEMs with each having a variety of cars. This creates a wide variety of types and combinations of peripheral devices connecting to the head unit. AGL UCB needs to be able to operate on multiple IVI system configurations. For example, AGL should support the various In-Vehicle Infotainment (IVI) systems, such as two different systems are shown in the Figure 1.

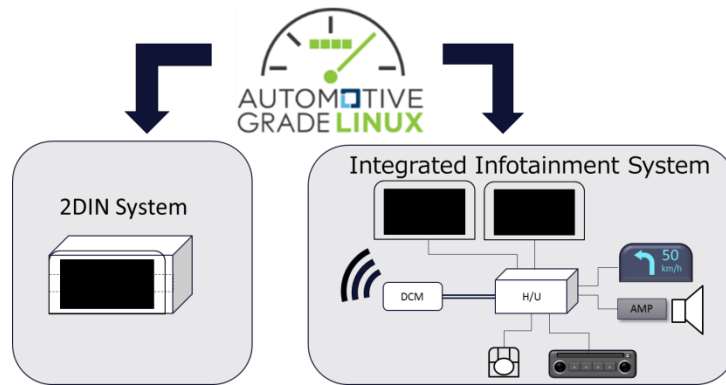

Figure 1 AGL should support two different systems

DRAFT

2.2. Use Case

The assumed Use Cases of the AGL reference hardware are following:

1. User: AGL community
 - UCB development and official demo
2. User: Institute/Tier2
 - Advanced research using vehicles
 - Product proposal (HW parts, cockpit)
 - Service proposal
 - Development tools
3. User: OEM/Tier1
 - Prior evaluation of the new generation communication Module
 - Performance evaluation with the SoC exchange

As mentioned section 1.1, one of the goals of the AGL reference hardware is to reduce the gap between the AGL reference hardware and product hardware (Figure 2).

Therefore it needs to reduce the gap assuming the product for the above Use Cases.

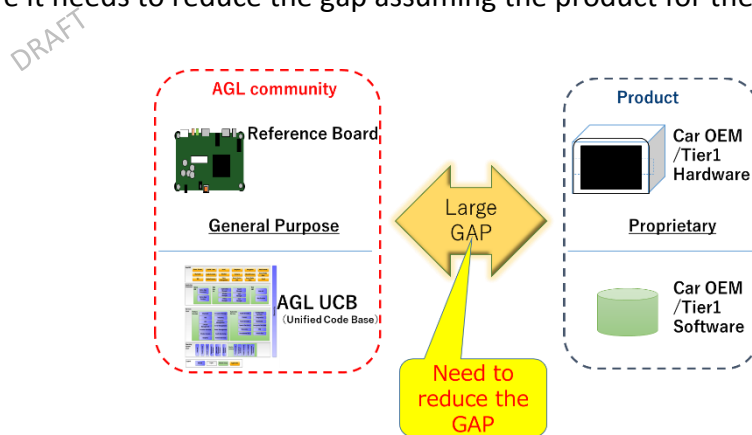

Figure 2 Need to reduce the gap between the AGL reference hardware and product hardware

2.3. Major policy

The major policies of the AGL Reference Hardware are following:

(1) SoC and peripherals are selectable and Interchangeable

The AGL Reference Hardware should adopt the diversification of IVI system configuration. So it should support many variations of main SoC to meet requirements for various kind of SoC, various range of CPU performance and many variations on the peripherals of IVI-HU.

(2) Open interface.

The AGL Reference Hardware should be open and public so that any user can use it for research and development of vehicle system. Any manufacturer can also use it for development and production. This feature encourages collaborative development which improves quality and functionality.

(3) Vehicle mountable

The AGL Reference Hardware should be built in vehicle system via 2DIN form factor and vehicle standard I/F. This feature enables to use environment close to real vehicle, which encourages advanced development, research and proposal.

DRAFT

2.4. Major feature

2.4.1. Selectable and Interchangeable architecture

It should have structure in which peripheral devices are selectable and interchangeable. It's realized by means of interchanging boards for each function (Figure 3). Each board which has specific functions should be selectable and interchangeable so that it can meet the requirements of the OEM.

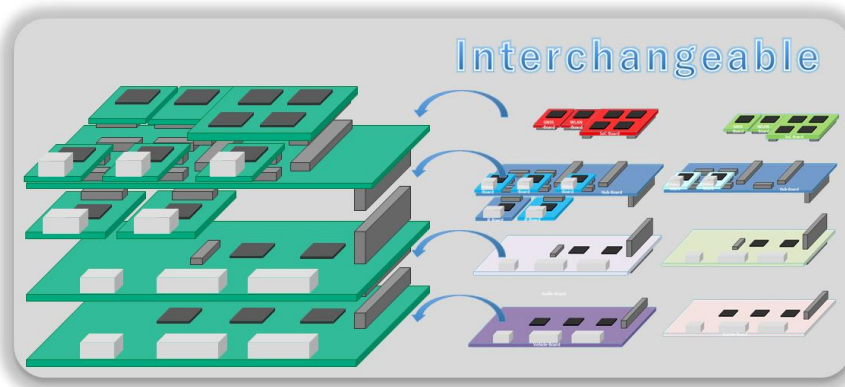

Figure 3 Selectable and Interchangeable architecture

DRAFT

2.4.2. Open Interface

It must have open interface to connect between the boards on the AGL Reference hardware. The interface is open and public interface so that any user can use it for research and development of vehicle system, and any manufacturer can use it for development and production.

2.4.3. Vehicle mountable structure

It must have structure which can be built in the vehicle. It must have form factor complaint to 2DIN (Figure 4).

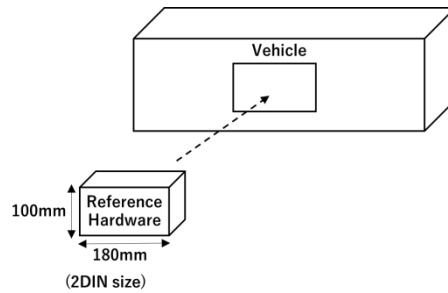

Figure 4 Form Factor of the reference hardware (2DIN size)

It must be able to connect vehicle system via vehicle data I/F (e.g. CAN, Ethernet, etc.) or vehicle power I/F (e.g. 12V).

It optionally has the enclosure around the Form Factor which can be hold inside vehicle by tighten screw (Figure 5), but it's just option because layout of screws is depend on each OEM.

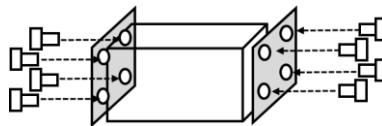

Figure 5 The enclosure which can hold inside vehicle mounter by tighten screw

2.5. Optional Feature

2.5.1. Selector

2.5.1.1. AV control device

The AGL reference hardware optionally has abstraction mechanism called “selector” to control many Input / Output signals of Audio / Video devices. The Selector may be realized as one kind of the Selectable and Interchangeable board mentioned in 2.4.1.

An IVI Head Unit (HU) is connected with many peripheral devices which send or receive Audio / Video signals. However the number of Audio / Video signals is limited by the capability of System on a Chip (SoC). To connect more Audio / Video signals than SoC capability, IVI-Hus optionally has a specific module which controls Audio / Video signals in order to mediate the signals and SoC capability. The specific module is called AV Stream Controller whose entity may be Audio DSP, Video ASIC or any other device (Figure 6 left).

On the other hand, IVI-HUs may connect the peripheral devices and SoC directly (Figure 6 right).

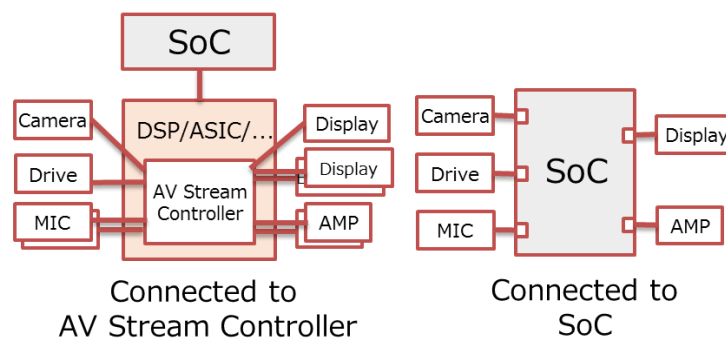

**Figure 6 Audio / Video signals connected to AV Stream Controller (left figure)
or connected to SoC (right figure)**

In order to realize this, it optionally have abstraction mechanism called “Selector” (Figure 7).

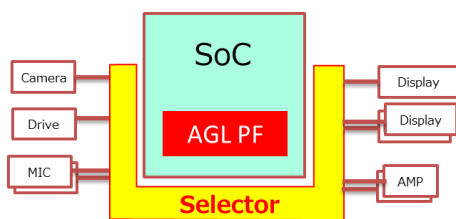

Figure 7 <T.B.D.> Abstraction mechanism called "Selector"

DRAFT

2.5.1.2. Location of peripheral devices

The AGL Reference hardware optionally has abstraction mechanism to support both peripheral devices of directly integrated into IVI-HU or separated from IVI-HU. It may be designed as one kind of the Selectable and Interchangeable board mentioned in 2.4.1.

Generally several peripheral devices are included in IVI system. And some of them (e.g. optical drive, tuner, display, etc.) may be integrated into IVI-HU or separated from IVI-HU. Thus AGL optionally support both compositions equivalently.

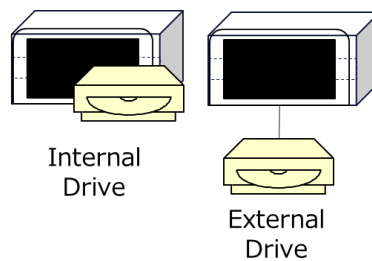

**Figure 8 Peripheral devices directory integrated into IVI-HU (left figure)
or separated from IVI-HU (right figure)**

In order to realize it, Selector optionally has hardware abstraction mechanism. The mechanism may be realized in device drivers (Linux kernel layer) or Hardware Abstraction Layer (HAL).

3. AGL Reference Hardware requirements

3.1. Selectable and Interchangeable Architecture

Figure 9 shows the structure of the AGL reference hardware. It is configured with 3 functional blocks shown in Table 2 . Each block is implemented as interchangeable board. Each board is connected with the connector which has same pin configuration of the signal.

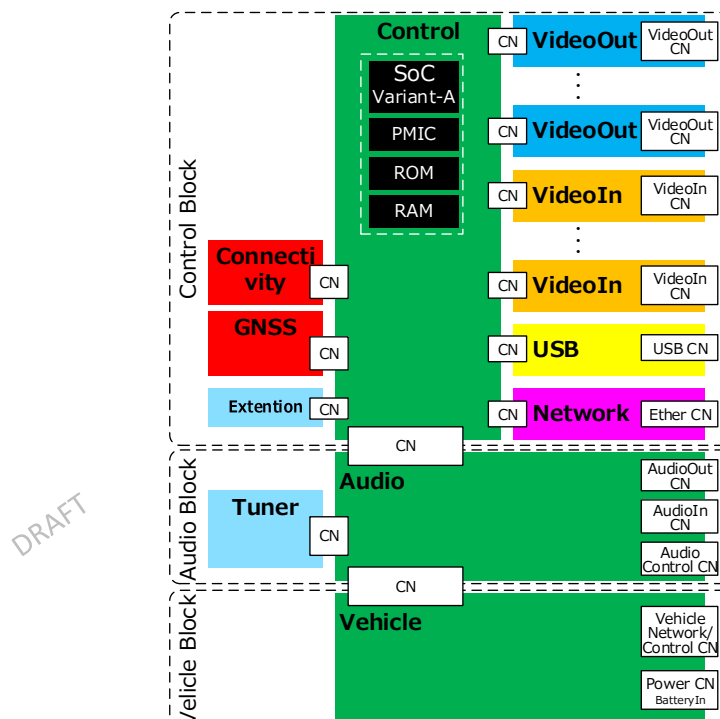

Figure 9 Selectable and Interchangeable architecture

Table 2 Components of AGL Reference hardware

Board Type	Function
Control Block	Control block has functions of high level operating system or multi-media processing. Control block should be divided to each function for flexibility and expandability, which are 7 functions: Connectivity as WLAN / Bluetooth, GNSS, Video Out, Video In, USB, High speed network as Ethernet, and other extended function. The functions are implemented on the small boards, and they are integrated to one Control board.
Audio Block	Audio block has Input / Output of audio signal.
Vehicle Block	Vehicle block has connection to vehicle with power supply, low speed legacy data interface as CAN or other vehicle signal.

DRAFT

3.2. Open Interface

The open interface should have design defining form factor of each board, connector specification between the boards, and interface specification, so that it realize selectable and interchangeable architecture. This design can meet the requirement of the OEM by minimum interchange of boards.

Figure 10 shows the example of interchanging SoC to the same vendor's one. It needs to interchange only the SoC board and don't need to replace the other boards to upgrade functionality.

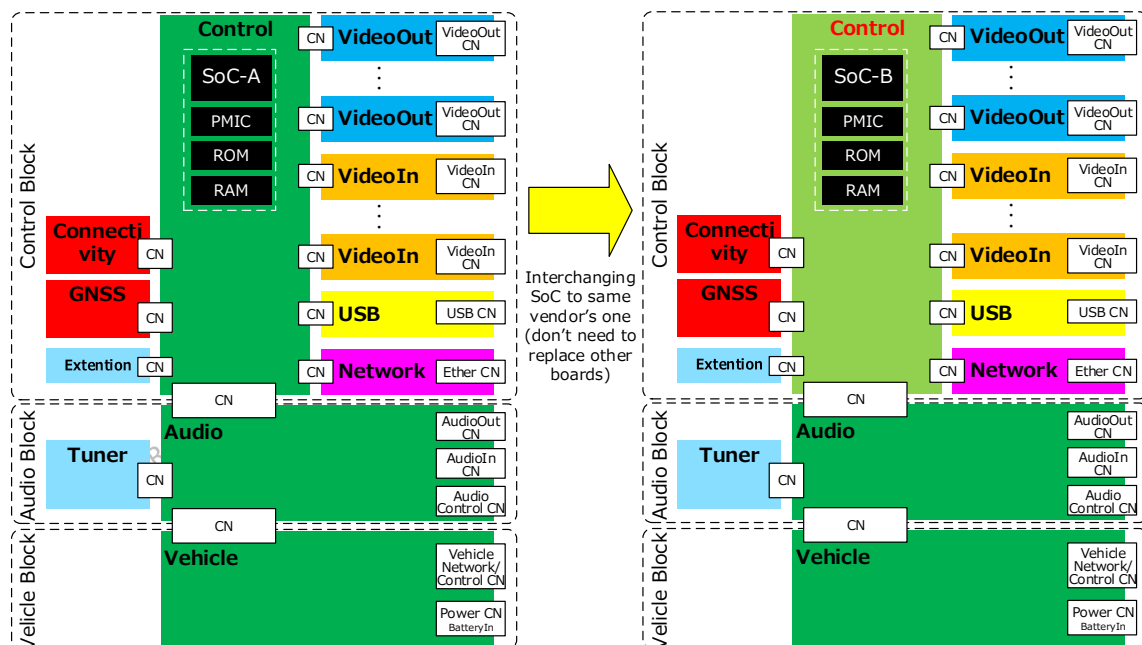

Figure 10 Interchanging SoC to same vendor's one

Figure 11 shows another example of interchanging the Video Out board to change only Video out signal. This example shows it needs to interchange just one board when it needs to replace one function.

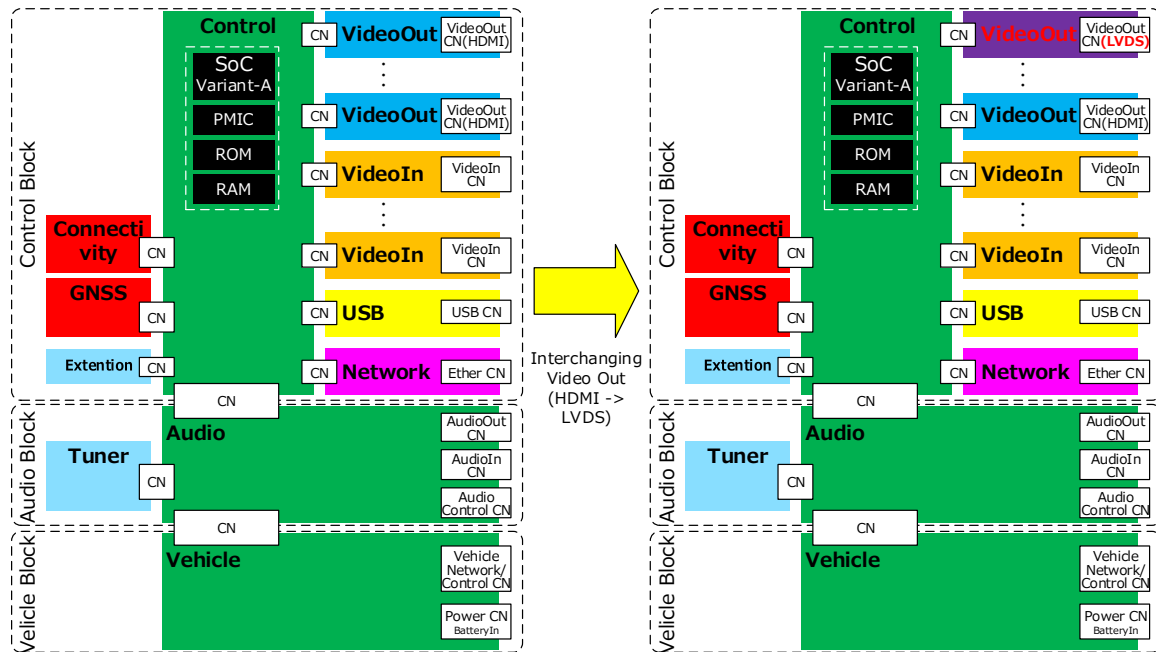

Figure 11 Interchanging Video Out (HDMI -> LVDS)

DRAFT

Figure 12 shows the other example of interchanging the SoC to the other vendor's one. It may need to replace the other boards because the different SoC may have different interface to the peripheral devices. In this case, Connectivity and 2 Video In boards need to be replaced as SoC board change.

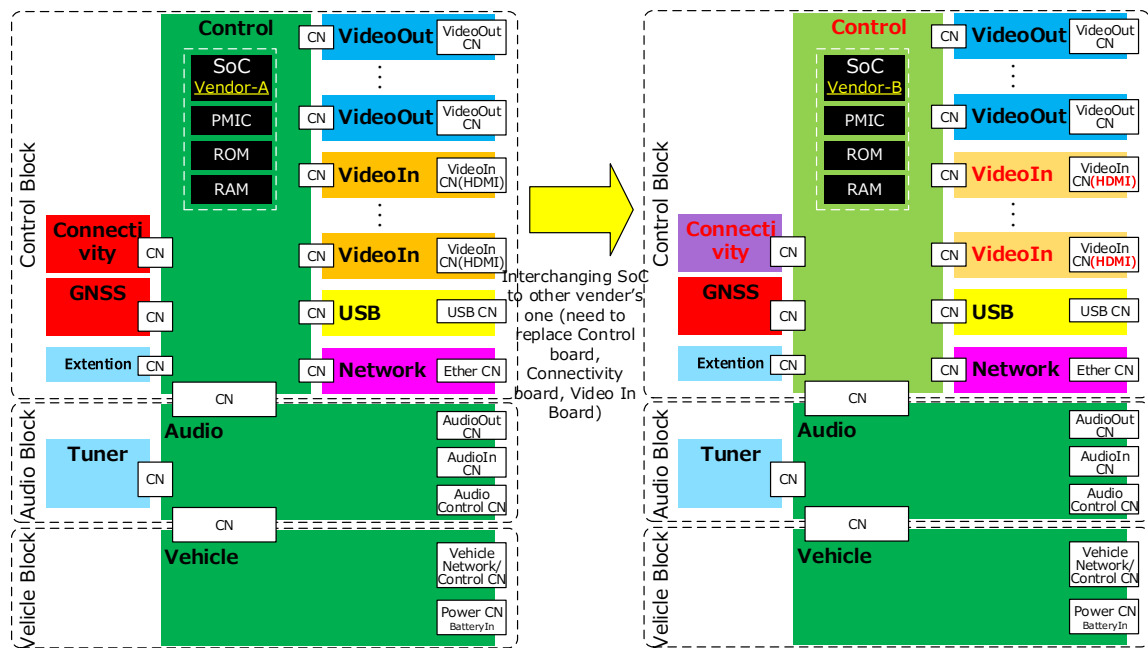

Figure 12 Interchanging SoC to other vendor's one

DRAFT

3.3. Vehicle mountable structure

It should be mountable to the vehicle by 2DIN form factor which has under 170mm depth (excluding cable) when all boards are integrated.

It should be also connectable to the vehicle I/F by the control / audio / vehicle board designed for the vehicle specification.

DRAFT

3.4. Hardware specification

Table 3 shows the hardware specification of the AGL reference hardware.

Table 3 Hardware specification

	Initial Specification	Extensibility
Input Voltage	DC 12V (10.5~16V)	-
Current Consumption	Under 10A	-
Operating Temperature	-10 to +60°C	-
SoC	Renesas R-Car H3	It's changeable to other SoC (other variant, or other Vendor) just by replacing board.
ROM	32GByte	It's changeable to other storage capacity just by replacing board.
RAM	4GByte	It's changeable to other memory capacity just by replacing board.
Video Out	HDMI x2	Maximum: x4 It's available other video signal (LVDS, GMSL, GVIF, FPD3, etc.) just by adding or replacing board. It's available to use multiple kinds of video signal at one time.
Video In	-	Maximum: x3 It's available other video signal (HDMI, CVBS, LVDS, GMSL, GVIF, FPD3, etc.) just by adding or replacing board. It's available to use multiple kinds of video signal at one time.
Audio Out	Φ3.5 Stereo jack x1	It's changeable to other audio signal just by replacing board.
Audio In	Φ3.5 Stereo jack x1	It's changeable to other audio signal just by replacing board.
Radio	-	It's available just by adding board.
Wifi	-	It's available multiple Wifi standards just by adding or replacing board.
Bluetooth	-	It's available multiple Bluetooth standards just by adding or replacing board.
GNSS	-	It's available multiple GNSS standards just by adding or replacing board.
Vehicle Network	CAN x1	It's available multiple channel or multiple network standards (CAN FD, LIN, IE-Bus, RS-485 etc.) just by replacing board.
High Speed Network	1000Base-T x1(for software development)	It's available multiple channel or multiple network standards just by replacing board.
USB	USB2.0 Host x1 USB2.0 OTG x1 USB2.0 Device (for software development) x1	It's available multiple channel or multiple USB standards (USB3.0 etc.) just by replacing board.
Internal Sensor	-	It's available multiple kinds of sensor (Gyro, Accelerometer, etc.) just by adding or replacing board.
SD Card	Micro SD (SDHC / SDXC) x1	-

Other	Mini PCI-Express x1 Connector x1	
-------	-------------------------------------	--

DRAFT

4. Peripheral devices and functional requirements

4.1. Video / Audio input peripherals

IVI-HU receives video streams and/or audio streams from the peripherals.

4.1.1. Camera

Use Case :

Front view camera, Rear view camera, Side view camera, In-Cabin camera etc.

- The image processing for surround view function is out of scope in this EG. (distortion correction, multi-viewpoint image composition, etc.) Other ECUs exterior to IVI-HU may take responsibility for surround view.

4.1.2. Optical drive

Use Case :

Media Player (CD / DVD / BD)

- The difference of internal HU and external ECU is optionally absorbed by device driver layer / HAL.
- There are two types of allocations of decoding function. So AGL PF should have both of them as follows.

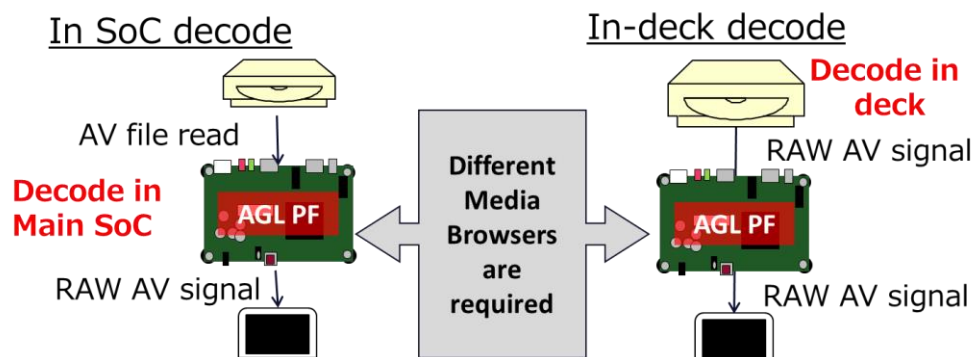

Figure 13 In SoC decode and In deck decode

4.1.3. Tuner

Use Case :

AM / FM radio, digital radio, digital TV, etc.

- The difference of internal HU and external ECU is optionally absorbed by device driver layer / HAL.
- In the case of supporting digital TV, not only audio stream but also video stream should be processed.

4.1.4. Microphone

Use Case :

Voice recognition, hands-free communication

- The difference of internal HU and external ECU is optionally absorbed by device driver layer / HAL.

4.2. Video / Audio output peripherals

IVI-HU sends video streams and/or audio streams to the peripherals. For the peripherals, the concept of Selector is required.

4.2.1. Display

Use Case :

Center information display (main / sub)

- It should support multiple displays.
- In the case of the touch panel displays, IVI-HU should receive the touch input signals from them.
- It should have I/F for connection to external display by the video cable with standard HDMI signal (Figure 14).

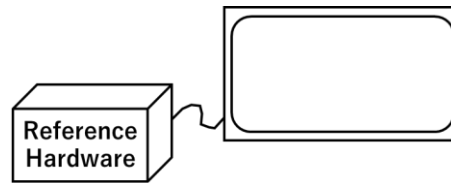

Figure 14 External display

- It optionally connect the display directory mount to the 2DIN form factor (Figure 15).

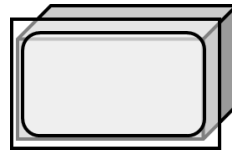

Figure 15 Directory mount display to 2DIN form factor

4.2.2. RSE

Use Case :

Rear Seat Entertainment (RSE) System

- In regard to function allocation, two patterns of RSE should be supported.
 - (a) It should accept simple commands such as volume change.
 - It should be fully controlled from IVI-HU at front seat.
 - It should be similar to multiple displays from the IVI-HU's point of view.
 - (b) It should have individual GUI and provides all the functions but Video / Audio source. Equivalent to tablet devices.
- Unlike display / cluster / Head-Up Display (HUD), IVI-HU must provide not only Video output but also Audio output.
- It should support Multiple RSE.
 - So it should support multiple Video / Audio output streams.

4.2.3. Cluster / HUD

Use Case :

Instrumental cluster, HUD, AR HUD

- In the current scope of Reference Hardware System Architecture Expert Group, Linux is not assumed as OS for cluster or HUD. So Virtualization (Hypervisor) is out of scope in this version of specification while more discussion about the topic is needed.
- It should support the function to send images and contents from IVI-HU to cluster / HUD. As an example, it optionally support surface sharing window system with other ECUs.

4.2.4. AMP / Speaker

Use Case :

Audio amplifier, speaker

- It should support multiple channels or multiple audio sink.
- The difference of internal HU and external ECU is optionally absorbed by device driver layer / HAL.

4.3. Data communication peripherals

4.3.1. Vehicle External Network devices

The devices mentioned in this section treat the data communication with the outside vehicle such as mobile communication network, smartphone connection.

4.3.1.1. DCM / TCU

Use Case :

Communication with a network outside the car (e.g. mobile communication network)

- In regard to emergency call, it should support both compositions below.
 - (a) IVI-HU should take responsibility for calling (audio input / output).
 - (b) It should work in DCM (Data Communication Module) / TCU (Telematics Communication Unit).

4.3.1.2. Wi-Fi / Bluetooth®

Use Case :

Communication with the smartphone via wireless connection or communication with a network outside the car (Wi-Fi spot, etc.)

4.3.1.3. USB

Use Case :

Communication with the smartphone via USB

- In this connection, Video / Audio streams should be also processed as the data communication.

4.3.1.4. ETC / DSRC

Use Case :

V2X Communication

4.3.1.5. NFC

Use Case :

Driver identification with a smartphone, etc.

4.3.2. Vehicle Internal Network devices

The devices mentioned in this section treat the information inside the vehicle except for the IVI-HU. There are various function allocations and various types of networks. For example, vehicle velocity signal may be analog signal of speed pulse or optionally be CAN signal through vehicle network. So vehicle data abstraction is required.

4.3.2.1. Vehicle Network

Use Case :

Getting vehicle data from the vehicle networks

- It should support CAN as major vehicle bus.
It should also support other vehicle networks. (CAN, CAN FD, LIN, etc.)

4.3.2.2. IVI Network

Use Case :

Getting vehicle data from the vehicle networks

- In some vehicles, vehicle network and IVI network is optionally separated because of security, workload, and so on.
It optionally supports various networks. (CAN, Ethernet, etc.)

4.3.2.3. Vehicle signal

Use Case :

Getting vehicle data from the vehicle networks

- It optionally supports directly connected lines such as analog signal, serial connection, and so on.

4.4. Other peripherals

4.4.1. Human Input devices

Use Case :

User input of HMI (touch panel, touch pad, commander, steering switch, etc.)

- Some signals from these devices are optionally transmitted through vehicle internal network. (CAN, etc.)

4.4.2. Navigation sensor

Use Case :

Vehicle positioning

- It should support GPS / G / Gyro sensors.

4.4.3. USB / SD (Media Storage)

Use Case :

Media Player (USB memory, SD card)

- In these cases, Video / Audio streams should be decoded in SoC.

DRAFT

5. AGL software requirements

5.1. AGL Latest Stable Release Support

- Basic function of AGL Latest Stable Release should work on the AGL reference hardware.
- Not only device driver but also any layer of basic software as application, middleware and so on should work on it.
- Applicable version of AGL release should be defined in Reference Hardware Expert Group.

5.2. Selectable and Interchangeable architecture Support

- It should support Selectable and Interchangeable architecture mentioned in section3.
- It should have device driver and other layer software working on SoC to control any peripherals on the AGL reference hardware.

5.3. Selector Support

- It optionally supports Selector mentioned in the section 2.5.
- It optionally collaborates with the User Interface and Graphics Expert Group. (Related to Audio routing, etc.)

5.4. Vehicle Data Abstraction

- It optionally supports the mechanism of vehicle data abstraction to absorb the variation of OEMs as mentioned in the section 4.3.2,.
- It optionally collaborates with the Connectivity Expert Group. (Related to vehicle data)

5.5. Cluster / HUD Support

- It optionally supports cluster / HUD, the function of sending images and contents from IVI-HU.
- It optionally collaborates with the User Interface and Graphics Expert Group.
(Related to multiple ECUs)

DRAFT

6. Notices

Linux is a registered trademark of Linus Torvalds.

Bluetooth® is a registered trademark of Bluetooth SIG Inc.

Blu-ray Disc is a registered trademark of the Blu-ray Disc Association.

Wi-Fi is a registered mark of the Wi-Fi Alliance.

DRAFT